

Bench Seat

SB-1248

- *Product Warnings*
- *Safety Guidelines*
- *Kit Contents*
- *Required Tools*
- *Preparation Tips*
- *Installation Procedure*
- *Cleaning & Maintenance*
- *Surface Repair*
- *Warranty Information*

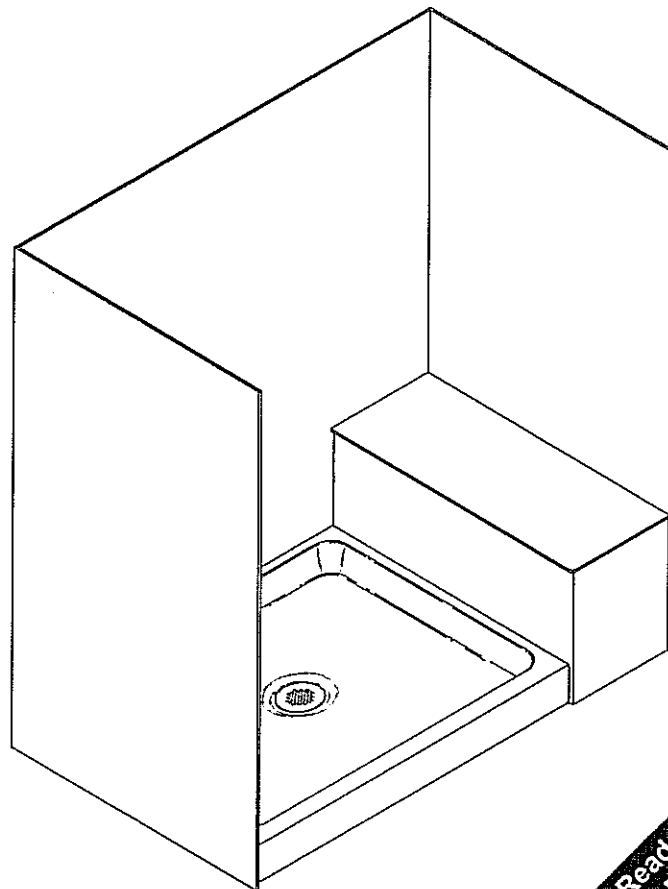

**Read and Understand
Before Installing**

The Swanstone Assurance — if our product is properly installed and maintained, as stated in these instructions, it will not leak.

Remember – Safety First

IMPORTANT NOTICE

The Swan Corporation, the makers of the Swanstone Wall Systems and Panels, cannot anticipate every possible circumstance that might involve a potential hazard during the installation of our product(s). The warnings and instructions in this installation guide are, therefore, not all-inclusive. If a tool, installation procedure, or work method that is not specifically recommended by the Swan Corporation is used, you must satisfy yourself that it is safe. You should also make sure that the Swanstone product(s) will not be damaged by the methods you choose. The Swan Corporation will not be held responsible for water damage of any kind in connection with the installation of one of our Swanstone bath/shower/panel kits.

! WARNING

To avoid product damage, personal injury, or even possible death, carefully read, understand, and follow all the instructions in this installation guide before installing this product(s). Do not use cleaning fluids or operate power tools unless you read and understand the instructions and warnings in this and all other applicable labels or manuals. Proper use of tools and the products described in this guide is your responsibility.

WARRANTY

This product is covered by a Limited Lifetime Warranty. Refer to the Warranty section in this manual for complete details.

Save this manual for future reference.

Important information on cleaning, maintenance, and repair is contained within.

Safety Guidelines

IMPORTANT NOTICE

IMPORTANT NOTICE: Indicates that equipment or property damage can result if instructions are not followed.



Read and Understand the Manual

It is the responsibility of any individual who installs or maintains this product to fully understand and follow proper installation and maintenance procedures. Be aware of the inherent dangers in the use of power tools when installing this product. Read and understand all Warnings, Cautions, and Important Notices in this manual.



Work Safely

DO NOT proceed if any doubt arises about the correct or safe method of performing anything found in this or other Swanstone manuals.

The installation of this product can require using power tools. Do not use power tools without adequate training. If necessary, hire or consult a trained professional for expert assistance before continuing.



Use Proper Tools

Always use proper tools which are in good, working condition during the installation of the Swanstone products. Using tools other than those listed could adversely affect the integrity of floors, pipes, walls, or this product and could result in water damage or other damage to floors, pipes, walls, or other portions of your building or home.



Do Not Use Nails

Do not use nails to secure the bench seat panel to the framing. The panel is mounted with clear silicone only. Only use

recommended clear silicone to attach this product. Never use hammers, nails, or screws which could adversely affect the integrity of this product. Nails and screws could puncture the Swanstone Wall Systems and Panels, resulting in water or other damage to floors, pipes, walls, or other portions of your building or home.



Inspect Before Cutting

Make sure no electrical wiring or plumbing is present before cutting into a wall.



Wall Conditions

Inspect the mounting surface before installing the panel. Never install the panel over damp material or an existing mold condition.

CAUTION

CAUTION: Indicates a potentially hazardous situation which, if not avoided, may result in minor or moderate injury. It may also be used to alert against unsafe practices.



Use Proper Installation Methods

Follow all instructions related to wall surface preparation. Failure to follow such instructions could cause the panels to detach from the wall surface after installation, resulting in personal injury. Failure to follow these instructions could result in water damage.



Slipping Hazard

Do not install this product in the presence of water. Installing this product without drying all surfaces, or in the presence of water, could cause you to slip and fall due to wet floors or spilled fluids. Personal injury can result from slips or falls. Before installation, dry all surfaces, including the floor, with a cloth or paper towel. Clean up all water or spilled fluids immediately.



Tripping Hazard

Personal injury can result from tripping over power cords, tools, or other items. **DO NOT** leave items laying around the work area.



Personal Protection

Be sure to use all personal protective equipment, such as sturdy work boots, preferably with steel toes, gloves, and hard hat, if necessary, to ensure your own safety. To prevent possible damage to your hearing, always wear ear protection, such as earmuffs or earplugs, when working around power tools.



Cutting Hazard

The installation of the Swanstone product may require using power tools. Keep hands away from the cutting edge of any tool used in the installation of our product. Placing fingers in or around the cutting blades could result in serious personal injury.



Sharp Edge Hazard

After cutting the edge of a Swanstone panel, it can be sharp. Wear protective gloves to prevent personal injury.



Room Temperature

Allow the Swanstone panel and silicone to adjust to room temperature for at least six hours

before installation. The panel should be installed at temperatures not less than 65 degrees. Panels should not be installed in areas where the temperature may drop below freezing (32°F). Failure to follow this recommendation could adversely affect the silicone which holds the panels to the mounting surface.



Dust Hazard

When cutting or drilling the Swanstone product, use a dust collection method which prevents dust particles from going into the air. Always work in a well-ventilated area. Always use an OSHA approved dust mask when cutting, drilling, or sanding Swanstone products.



Power Tool Hazard

To prevent personal injury or possible death, always follow the electrical safety recommendations of the power tool's manufacturer. Do not use power tools in an unsafe manner. Power tools should only be connected to a circuit protected by a ground-fault circuit interrupter (GFI).

! WARNING

WARNING: Indicates a potentially hazardous situation which, if not avoided, could result in serious injury or death.



Eye Protection

Be sure to use all personal protective equipment to ensure your own safety. To avoid eye injury, always wear protective glasses with side shields when using power tools. Also, make sure no one else can be injured by flying particles when using power tools.



Shock Hazard

Never use electric power tools around water, condensation, or other liquids. Electric shock can cause severe burns, significant injuries, and even death. If an extension cord is required, always use an OSHA approved extension cord. Power cords should only be connected to a circuit protected by a ground-fault circuit interrupter (GFI).



Fire Hazard

Personal injury or death can result from a fire caused by flammable liquids or

silicone. Cleaners or solvents can be highly explosive, resulting in personal injury or even death, when not used properly. Clean up any flammable substance immediately. Sparks or open flames can cause flammable substances to ignite. DO NOT smoke while working on or near any flammable substance.



Electrical Shock Hazard

Contacting live electrical wiring with power tools or hand tools can cause serious injury or death. Make sure all related circuit breakers are turned OFF. Test for live circuits or wiring inside any wall where installation of the Swanstone product requires cutting into a wall.



Solvents Hazard

Follow all manufacturer's safety instructions for silicone and denatured alcohol. Alcohol vapors are both flammable and hazardous to breathe. Silicone vapors may irritate eyes and nose. Personal injury can result from improperly handling or use of products such as denatured alcohol. Always follow the manufacturers recommendations for the safe use of these products. Ventilate any work area before beginning to apply silicone, cleaning agents, or solvents.



Electrocution Hazard

Water and other liquids conduct electric current and can create a short circuit, resulting in injury or death. Keep all liquids away from electrical cords and power tools. DO NOT create a short circuit between a source of electricity and a liquid by being in contact with both simultaneously.



Fumes Hazard

The fumes from the silicone and solvents used by the installer can be harmful if used in an unventilated room. Always work in a well-ventilated area.

General Information

Required Tools

- Circular saw with 60 to 80 tooth carbide blade
- Tape measure
- Masking tape (2" wide works best)
- Caulking gun
 - Color Match Caulk or Sealant¹
- Clean paper towels or shop towels
 - 100% Clear Silicone Sealant

Kit Contents

Confirm that all parts of this kit have been included before beginning installation.

SB-1248 Bench Seat Kit

(51-5/16 long x 14 wide x 1-9/16" thick; 16.5 lbs.)

- 1 — Seat Panel (12-3/4" x 48" x 0.400")

Unpackaging

- Use care when opening the box so that you do not damage the panel.
- This product is shipped to you or your retail center after careful inspection. After purchasing the kit, carefully unbox and inspect the product for any shipping damage that may have occurred. If damage is found, report it immediately to the store of purchase. After inspection and during installation, protect the products from construction damage, by moving them to another room or area until ready to install.
- Store the panel in a flat area to avoid warpage until the time of installation. Do not store the panel outside of the original packaging in a vertical position.
- Please use the model number located on the side of the box or the front of this manual when contacting us with questions concerning the installation of this unit.

Helpful Hints

- Read these instructions carefully and familiarize yourself with the various parts of the kit.
- The variety of installations possible for this kit may require procedures other than those shown. Ensure construction is correctly sized, plumb, and square.
- Allow sufficient time for the parts in this kit to adjust to room temperature. We do not recommend installation of this product at temperatures below 65 degrees.
- Saw horses with 2 x 4 cross-members or a worktable is helpful during the installation process.
- Always transport the panels vertically. Use care when laying the panels flat to prevent flexing, especially when panels have a cutout in them.
- Store unused materials away from the work area to prevent accidental damage.

Preparation Tips

- Turn off the hot and cold water supply.
- Ensure all plumbing or electrical work inside the walls is finished prior to installation of the bench seat.
- Prepare the area with 1/2" (13 mm) moisture-resistant drywall, marine grade plywood, or concrete board. Never install our products directly on any surface that is, or may become, wet or damp.
- Trial fit the panel before you begin. Swanstone panels have a finished side and a nonfinished backer side. The Swanstone panel has a sticker or stickers attached to the nonfinished backer side and, upon installation, should be placed against the mounting surface.
- The mounting surface must be free of dirt, film, waxes, or any other residues.

Caulking Tips

- Follow the instructions on the caulking tube.
- When job is complete, inspect all caulked areas for gaps and fill as needed.
- Clean up any excess silicone that was missed using denatured alcohol and a clean cloth.
- Be very careful not to disturb caulk joints.

Swanstone panels can be installed over a variety of products. If you intend to apply the panels to any surface other than those described, consult with a professional contractor. Use the following sections when installing this product over:

- SHEETROCK/GREENBOARD/CEMENTBOARD/
WOOD

**Sheetrock, Greenboard, Cementboard, or
Wood**

- Surface must be dry, smooth, and free of any dust, soap scum, or any other contaminants.
- To ensure proper adhesion of the Swanstone product, the wall surface must be sealed with a water or oil-based primer/sealer.
- After the primer/sealer is completely dry, complete the installation following the instructions in this manual.

Followed carefully, these installation instructions will result in an easy, trouble-free installation of your Swanstone product. Any deviations, additions, and/or deletions from the prescribed installation, without prior written approval of our Customer Service Department, will void the warranty covering this product. Not following the directions could also result in personal injuries, water damage, and other damage to floors, pipes, walls, and other portions of your building or home.

Disclaimer

- The information contained in this Installation Manual is given free of charge. It is based upon technical data which we believe to be reliable and is intended for use, by persons having knowledge of this technical area, at their own discretion and risk. Swanstone assumes no responsibility for results obtained or damage incurred from the use of this material either in whole or in part by the buyer.
- This manual will give you basic instructions for the installation of the product in a step-by-step sequence that will work in most types of installations. If you have an installation application that is not covered in this manual, please call your local Swanstone distributor or contact the Swan Corporation directly for additional information about your application.
- Follow all installation instructions. Failure to follow these instructions could result in personal injuries, water damage, or other damage to floors, pipes, walls, or other portions of your building or home.

The illustrations in this section show new construction, but the seat can be added to an existing shower enclosure.

1. Add a 2 x 4 wall brace to attach the seat framing. The height of the brace should be the same height as the seat, which can vary according to personal needs.

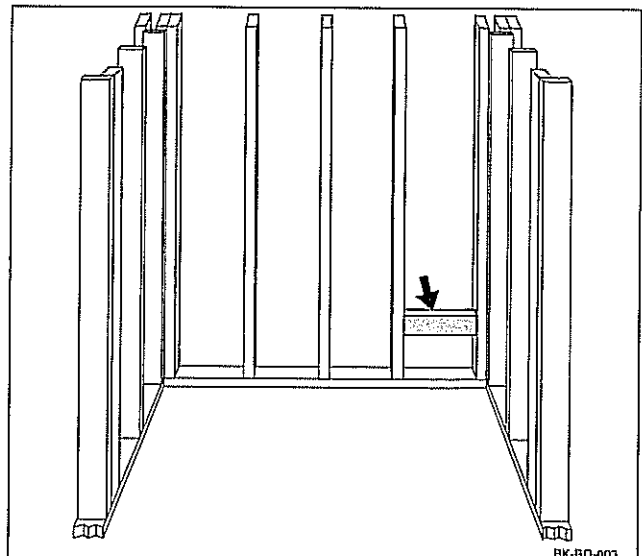

Installation Procedure

- Construct the bench seat framework, as shown, using 2 x 4 wood or steel studs. The framework for the seat must be 11-3/4" deep and can be up to 47-1/2" long, depending on your application.

IMPORTANT NOTICE

The center braces are necessary to adequately support the weight placed on the seat. Failure to install these braces will void any product warranty.

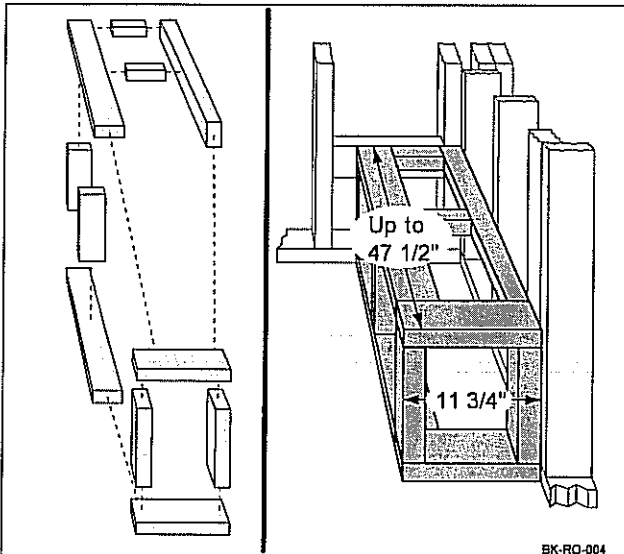

- In order to eliminate standing water on the bench seat, cut and place three, 2" wide shims on top of each 2 x 4, as shown. Standard shim stock works well for these shims. The shims should be 1/8" thick and taper down to nothing. Also, place a 1/8" thick shim along the wall to completely support the back of the seat.

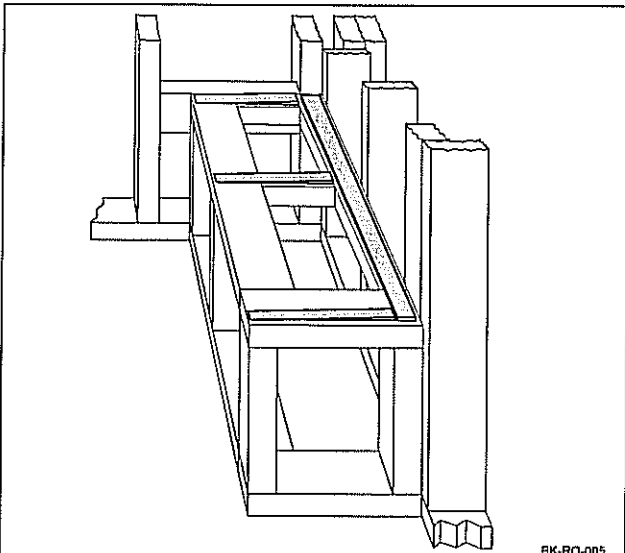

- Install 1/2" moisture-resistant cement board or greenboard over all the surfaces of the seat area (1, 2, & 3). Follow the wall board manufacturer's recommendations for installation.

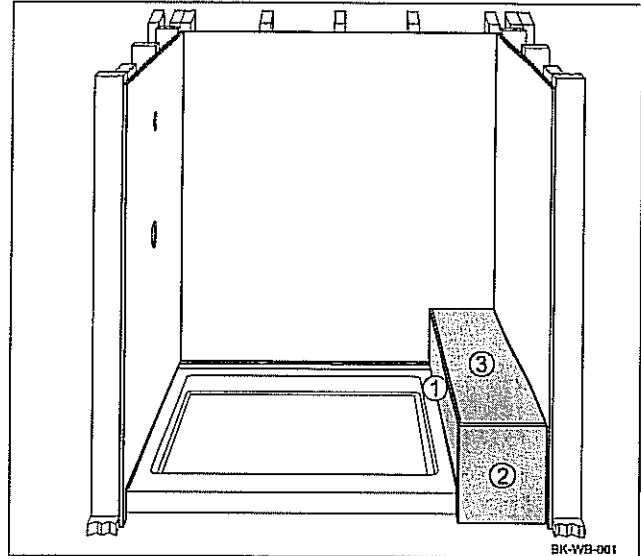

- Apply a coat of water or oil-based primer/sealer to all the surfaces of the cementboard or greenboard (follow the manufacturer's instructions). Allow the primer to dry thoroughly before applying any clear silicone.

WARNING



Dust Hazard

When cutting or drilling the Swanstone product, use a dust collection method which prevents dust particles from going into the air. Always work in a well-ventilated area. Always use an OSHA approved dust mask when cutting, drilling, or sanding Swanstone products.

6. Cut the seat panel to length.

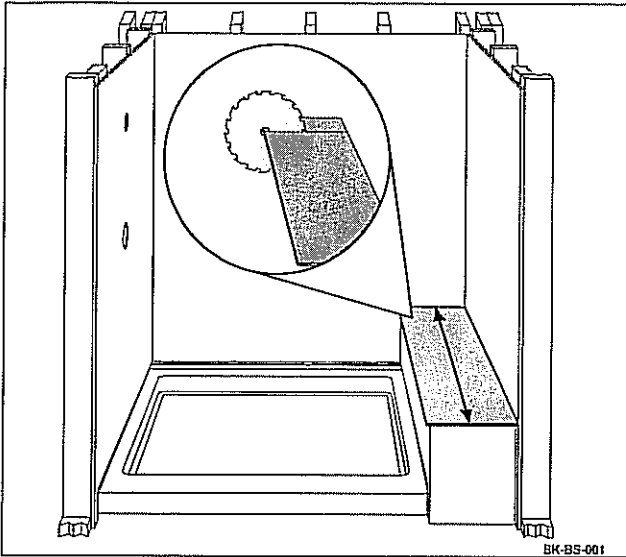

NOTE: The length of the seat can vary, depending on the amount of desired overhang and the type of material used to cover the end of the bench. The width of the seat is pre-cut to 12-3/4" to provide a 1/2" overhang.

WARNING



Fumes Hazard

The fumes from the silicone and solvents used by the installer can be harmful if used in an unventilated room.

Always work in a well-ventilated area.

7. Clean the back of the panel with denatured alcohol or another non oil-based cleaning solvent.

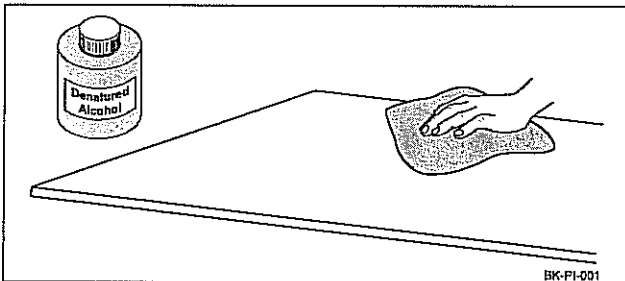

IMPORTANT NOTICE

Do not use oil-based cleaners, such as mineral spirits, to clean the panels. The oil in the cleaner will prevent the panel from adhering properly to the wall.

8. Apply the silicone in 1-1/4" diameter dots 8 to 10 inches apart over the surface of the panel. Follow the silicone manufacturer's instructions and note all ventilation and installation precautions.
9. Place the seat, with the rounded edge facing out, onto the clear silicone. Make sure the seat is correctly positioned and place weight on top of the seat to hold it firmly in place.

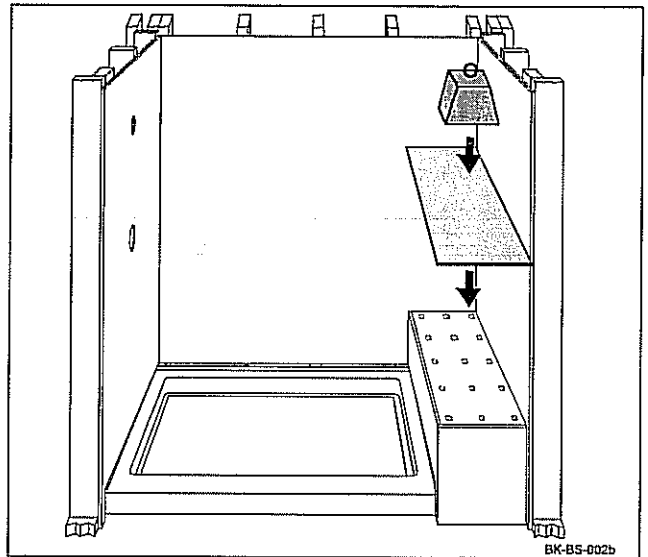

IMPORTANT NOTICE

Follow the manufacturer's instructions on the tube for proper application. Allow at least 24 hours for clear silicone to set before using the shower enclosure.

10. Apply a bead of the color-matched 100% silicone sealant on the top edges of the bench seat. Also apply a bead of the color-matched 100% silicone sealant under the front edge of the seat panel.

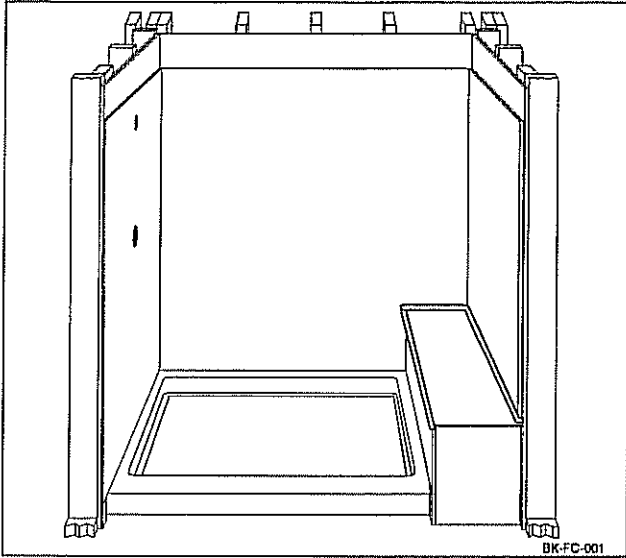

The installation is now complete. DO NOT discard these installation instructions. PLEASE LEAVE THEM WITH THE HOMEOWNER.

Care and Cleaning

The Swanstone products are stain and abrasion resistant; however, the finish requires reasonable care.

IMPORTANT NOTICE

Because cleaning products change over time, always check the manufacturer's instructions to make sure it is compatible with plastic. **DO NOT** use a cleaner if the label indicates it should not be used on plastics. **DO NOT** use spray-on cleaners that require daily use without immediately rinsing with water to stop the chemical cleaning reaction because damage will result and void the warranty.

Day-To-Day Cleanup

Simply wipe the surfaces with a clean towel to remove watermarks and residues. All Swanstone products can be cleaned with warm water, a soft cloth, and normal household detergents or cleansers, such as Fantastic, Formula 409, Clorox Clean-up, Handy Andy, Mr. Clean, or Lestoil. Always rinse off cleaners within five minutes of application.

Occasional scrubbing with household abrasive cleaners ensures that the original luster is maintained.

Caulking Joints

Inspect caulking joints monthly for damage or any signs of separation from the mating surface. Cracks in the caulking will allow water to leak into the surrounding surfaces. **Reapply caulking to any joint showing signs of wear or cracking.** Failure to inspect and repair caulking joints will void the warranty.

Surface Repair

Light Scratches

Use 400 grit sandpaper to remove light scratches in the surface.

Deep Scratches or Gouges

For deeper scratches or gouges, use 220 or 320 grit sandpaper. A "Scotchbright pad" can be used to blend the repair into the surrounding area.

LIMITED WARRANTY FOR RESIDENTIAL APPLICATIONS

If a Swanstone product covered by this warranty is found to be defective in materials or workmanship, after inspection by an authorized Swan Corporation representative, we will repair, or at our option, exchange the product for a similar model. This warranty extends for a designated period of time, so long as it remains in use in its original place of installation.

This warranty covers products installed in accordance with the Swan Corporation's installation instructions, used as recommended, and not damaged due to misuse, abuse, or improper installation. It does not apply to any seams or changes made to the product by professional tradesmen or fabricators.

The warranty applies only to the original purchaser and installation of these products in residential applications. It does not apply to commercial applications.

The Swan Corporation's option to repair or exchange the products under this warranty does not cover any labor or other costs of removal or installation, nor shall the Swan Corporation be responsible for any other incidental or consequential damages attributable to a product defect or to the repair or exchange of a defective product.

Limited Lifetime Warranty

Swanstone Wall Panels, Trim Kits, and Accessories

LIMITED WARRANTY FOR COMMERCIAL APPLICATIONS

If a Swanstone product covered by this warranty is found to be defective in materials or workmanship, after inspection by an authorized Swan Corporation representative, we will repair, or at our option, exchange the product for a similar model. This warranty extends for a designated period of time, so long as it remains in use in its original place of installation.

This warranty covers only products installed in accordance with the Swan Corporation's installation instructions, used as recommended, and not damaged due to misuse, abuse, or improper installation. It does not apply to any seams or changes made to the product by professional tradesmen or fabricators.

The warranty applies only to the original purchaser and installation of these products in commercial applications.

The Swan Corporation's option to repair or exchange the products under this warranty does not cover any labor or other costs of removal or installations, nor shall the Swan Corporation be responsible for any other incidental or consequential damages attributable to a product defect or to the repair or exchange of a defective product.

25-Year Limited Warranty

Swanstone Tub and Shower Wall Panels, Trim Kits, and Accessories

Save these Installation Instructions for future reference. They provide important information on cleaning, maintenance, and surface repair of the Swanstone Wall Systems and Panels.

